

# DN1200

## USER MANUAL

Multifunctional Amplifier for  
Deskphone and Softphone

### Product Overview

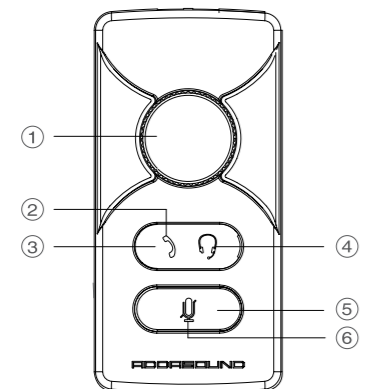

- 1. Speaker volume control
- 2. Handset indicator
- 3. Handset/Headset selector button
- 4. Headset indicator
- 5. Mute button
- 6. Mute indicator
- 7. Headset port 1
- 8. Headset port 2

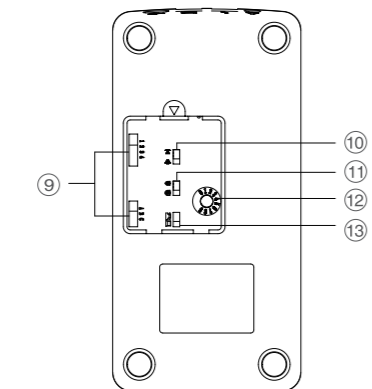

- 9. Compatibility slide switch
- 10. Voice clarity switch
- 11. Hearing protection switch
- 12. Microphone volume control
- 13. Phone/PC switch
- 14. USB port
- 15. Telephone port
- 16. Handset port
- 17. Reserved port

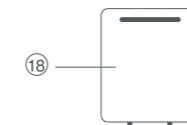

18. Back cover

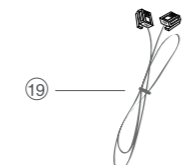

19. Short telephone cord, RJ9 to RJ9

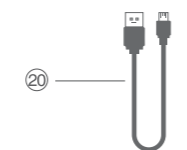

20. USB cable



21. Screwdriver

### Optional accessories

The following accessories are available purchased separately.

- USB power adapter
- QD (Quick-Disconnect) to RJ9 cable

### Button and Function

Button/Switch/Port	Function
1 Speaker/Receive volume control knob	Adjust the speaker volume, turning clockwise to increase the volume and counterclockwise to decrease.
2 Handset indicator	Talking by the handset is enabled when the indicator is on; Talking by the handset is disabled when the indicator is off.
3 Handset/Headset selector button	Press the button to switch between handset and headset.
4 Headset indicator	Talking by the headset is enabled when the indicator is on; Talking by the headset is disabled when the indicator is off.
5 Mute button	Press the button to mute the microphone.
6 Mute indicator	Muting the microphone is enabled when the indicator is on; Muting the microphone is disabled when the indicator is off.
7 Headset port 1	Connect the headset with RJ9 plug.
8 Headset port 2	Connect the headset with RJ9 plug.
9 Compatibility slide switch	Try all of the switch positions in the following 12 orders until the headset users get the best dial tone and clearest voice: A1,A2,A3,A4,B1,B2,B3,B4,C1,C2,C3,C4.
10 Voice clarity switch	Open/close the function of voice clarity.
11 Hearing protection switch	Open/close the function of hearing protection.
12 Microphone/Transmit volume control knob	Adjust the microphone volume, turning clockwise to increase the volume and counterclockwise to decrease.
13 Phone/PC switch	Choose between desk phone and PC to determine the headset audio source.
14 USB port	Micro-USB port, plug the USB cable to this port.
15 Telephone port	Connect desk phone to the port by the short telephone cord (#19).
16 Handset port	Connect the handset of desk phone to the port.

Button/Switch/Port	Function
17 Reserved port	Reserved port, no function.
18 Back cover	Secure and cover the switches at the bottom of the amplifier.
19 Short telephone cord	Connect the amplifier to desk phone, RJ9 to RJ9.
20 USB cable	Connect the USB port of the amplifier to PC.
21 Screwdriver	Rotate the microphone volume control knob to adjust the microphone volume.

### Installation Instruction

#### 1. Connect to power

To connect to power, you can plug the USB cable (#20) to USB port of DN1200 (#14) and then, connect the other end of the USB cable (#20) into any USB port of PC or USB power adapter (optional accessory sold separately).

The handset indicator (#4) will light up green and the mute indicator (#6) will flash red three times to indicate the amplifier is successfully connected to power.

#### 2. Connect DN1200 to desk phone

Set the Phone/PC switch (#13) to the Phone position.

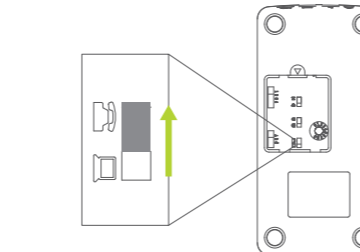

#### A. Connecting DN1200 to the telephone with a headset port

Plug the short telephone cord (#19) into DN1200's telephone port with the telephone symbol (#15), and then insert another end of this cord into the handset port on your desk phone. Now DN1200 is connected to the desk phone.

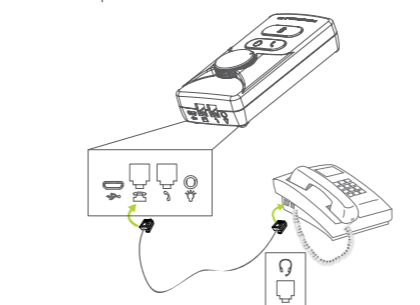

#### B. Connecting DN1200 to the telephone without a headset port

Unplug the handset coiled cable from the handset port of the desk phone, and then insert it into the handset port (#16) of DN1200.

Connect the telephone cable (#19) to the telephone port (#15) of DN1200, and plug the other end of the cable into the handset port of the desk phone. Now DN1200 is connected to the desk phone.

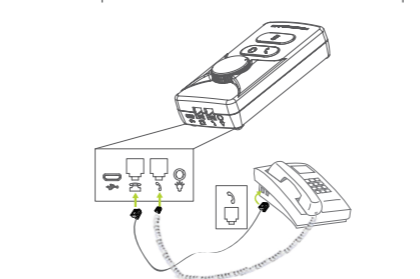

#### 3. Connect DN1200 to PC

Set the Phone/PC switch (#13) to the PC position.

Make sure one end of the USB cable (#20) is plugged into the USB port of DN1200 (#14) and the other end into any USB port on the PC.

Now DN1200 is connected to PC.

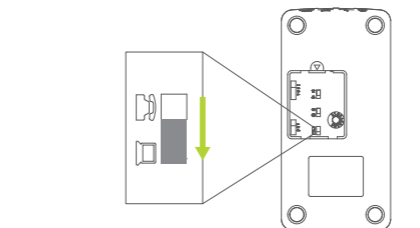

#### 4. Connect to a headset

Use the QD to RJ9 cable to connect the QD headsets to the headset port of DN1200 (#7 or #8).

Both of the headset ports (#7 or #8) are available to use and the two headset users could join one conversation together.

### Usage Instruction

#### 1. Locate the compatibility slide switch (#9) for desk phone

Press the headset button on the desk phone, or take the desk phone handset off the hook and place a call.

Try all of the switch positions in the following 12 orders until the headset users get the best dial tone and clearest voice:  
A1,A2,A3,A4,B1,B2,B3,B4,C1,C2,C3,C4. Try from A1 first.

#### 2. Adjust the microphone volume

Adjust the microphone volume control knob (#12), turning clockwise to increase the volume and counterclockwise to decrease to determine the best volume and minimal background noise.

Make sure the caller does not adjust his/her own volume during the adjustment.

#### 3. Adjust the receive volume

Adjust the receive volume control knob (#1) by rotating the knob until you hear a comfortable volume level.

#### 4. Mute the microphone

Press the mute button (#5) to mute the microphone. The mute indicator (#6) shows red color.

Press again to un-mute the microphone. The indicator will turn off.

#### 5. Switch between handset and headset

Press the handset/headset selector button (#3) to switch between handset and headset.

The user could receive the call by headset when the headset indicator (#4) lights up.

The user could receive the call by handset when the handset indicator (#2) lights up.

### Advanced Setting

#### 1. Advanced setting-voice clarity switch

Open the function of voice clarity by sliding the voice clarity switch (#10) to the symbol marked .

The user could hear the increased clarity of the incoming voice. It is back to normal when the switch is sliding to the symbol marked .

#### 2. Advanced setting-hearing protection switch

Open the function of hearing protection by sliding the hearing protection switch (#11) to the symbol marked . It prevents the user from acoustic shock.

### Trouble Shooting

#### 1. There is an echo in my headset when I talk.

The microphone volume may be too high. Turn down the volume of the microphone on your DN1200.

#### 2. The callers can't hear me.

- Make sure mute switch is not turned on.
- Ensure the microphone boom is positioned one or two fingers away from the user's mouth.
- Ensure the correct desk phone/PC switch is chosen.
- Make sure the correct order of compatibility switch is chosen.
- Adjust the microphone volume.

#### 3. I can't hear the callers.

- Ensure all of the cords are connected correctly.
- Ensure the correct desk phone/PC switch is chosen.
- Make sure the correct order of compatibility switch is chosen.
- Adjust the speaker volume.

### Limited Warranty

ADDASOUND offers a two-year limited warranty. Please visit our website ([www.addasound.com](http://www.addasound.com)) for more warranty details.

### Accessories

DN1200 amplifier	X1
Short telephone cord	X1
USB cable	X1
User manual	X1
Warranty card	X1
Screwdriver	X1



# DN1200

## 使用手册

一款适用于座机和PC电话的适配器

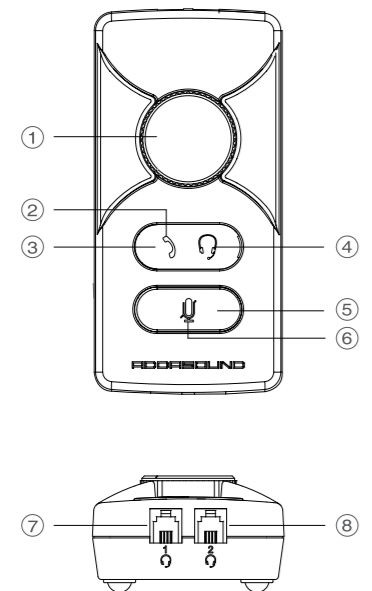

- 1. 耳机喇叭音量调节旋钮
- 2. 话柄选择指示灯
- 3. 话柄/耳机选择按键
- 4. 耳机选择指示灯
- 5. 耳机麦克风静音按键
- 6. 耳机麦克风静音指示灯
- 7. 耳机接口1
- 8. 耳机接口2

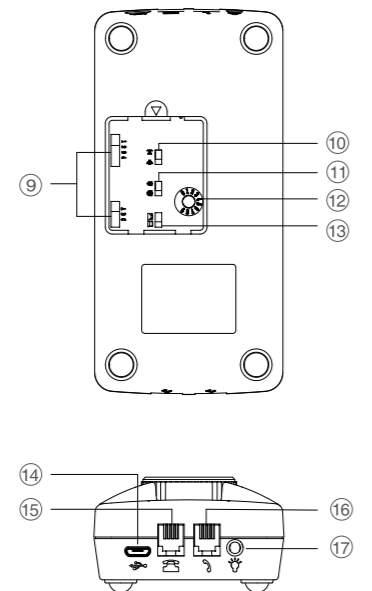

- 9. 清晰拨号音适配档位
- 10. 语音清晰度开关
- 11. 听力保护开关
- 12. 耳机麦克风音量调节旋钮
- 13. 座机/电脑选择开关
- 14. USB连接口
- 15. 座机电话连接口
- 16. 座机话柄连接口
- 17. 预留功能接口

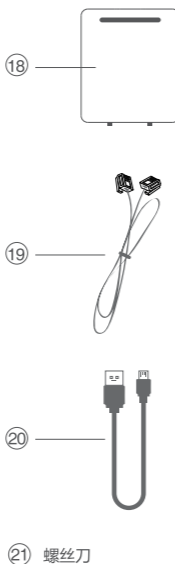

### 可选配件

- 以下配件可单独购买
- USB 电源适配器
- QD转RJ9连接线

### 功能及按键

1	耳机喇叭音量调节旋钮	调节耳机喇叭音量大小：顺时针旋转增大音量，逆时针旋转减小音量
2	话柄选择指示灯	指示话柄选择状态：点亮表示选择话柄通话，熄灭表示禁用话柄
3	话柄/耳机选择按键	话柄通话/耳机通话选择按键，每次点击触发切换一次
4	耳机选择指示灯	指示耳机选择状态：点亮表示选择耳机通话，熄灭表示禁用耳机
5	耳机麦克风静音按键	控制耳机麦克风静音与否，每次点击触发切换一次
6	耳机麦克风静音指示灯	指示耳机麦克风静音与否，点亮表示耳机麦克风静音，熄灭表示恢复正常
7	耳机接口1	RJ9-4P4C耳机接口
8	耳机接口2	RJ9-4P4C耳机接口
9	清晰拨号音适配档位	通过拨动开关档位，来获得最佳拨号音质。通过1、2、3、4和A、B、C的配合，共有12个档位可供选择
10	语音清晰度开关	控制耳机喇叭的语音清晰度
11	听力保护开关	控制是否进行听力保护
12	耳机麦克风音量调节旋钮	控制耳机麦克风音量，顺时针增大，逆时针减小
13	座机/电脑选择开关	选择耳机的音频来源为座机还是电脑
14	USB连接口	Micro USB连接口，连接到电脑USB接口或者5V电源适配器
15	座机电话连接口	连接座机电话RJ9-4P4C接口
16	座机话柄连接口	连接座机电话话柄线
17	预留功能接口	预留接口，暂无功能
18	适配器后盖	保护和覆盖放大器底部的开关
19	电话音频线	将放大器连接到桌面电话
20	USB充电线	将放大器的USB端口连接到PC
21	螺丝刀	旋转麦克风音量控制旋钮来调节麦克风音量

### 安装方法

#### 1. 连接电源

可通过两种方式供电：通过 USB 线连接到电脑 USB 口为 DN1200 供电；或者连接到 5V 电源适配器为其供电。

#### 2. 连接座机电话

将座机 / 电脑选择开关拨到座机端  
 (1) 对于有耳机接口和话柄接口的座机电话，可将座机电话耳机口与 DN1200 的座机电话连接口相连，然后将耳机接在 DN1200 耳机接口位置。

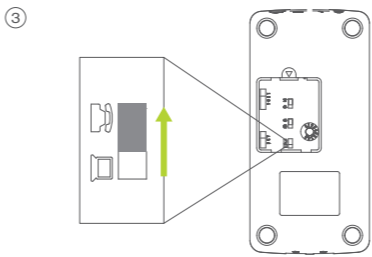
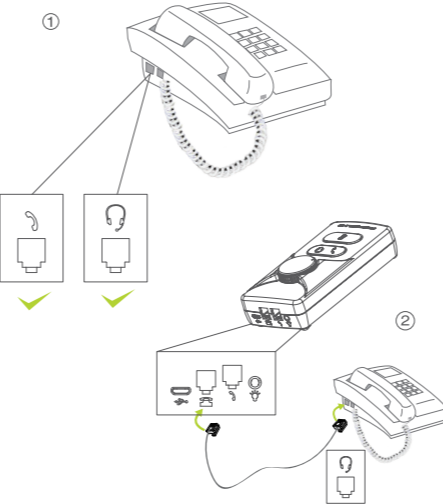

(2) 对于没有耳机接口，仅有话柄接口的座机电话，可将座机电话的话柄接口与 DN1200 的座机电话连接口相连，然后将座机电话的话柄接上 DN1200 的座机话柄连接口，再将耳机接上 DN1200 耳机接口位置。备注：耳机接口 1、2 可同时使用。

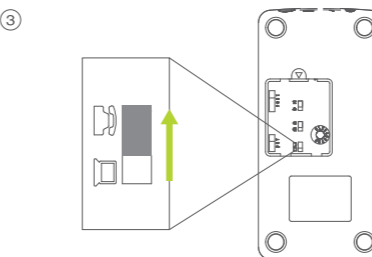
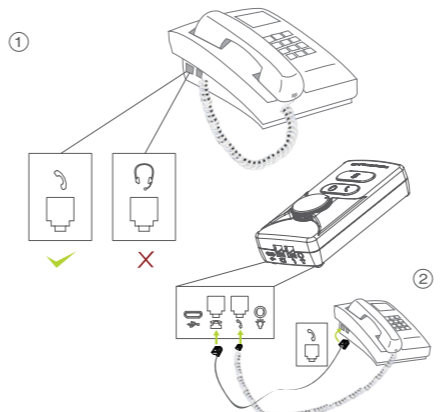

#### 3. 连接电脑 (PC 软电话)

- (1) 需要通过 USB 线连接到电脑 USB 口为 DN1200 供电，等待电脑安装驱动；
- (2) 将座机 / 电脑选择开关拨到电脑端
- (3) 将耳机接上 DN1200 耳机接口位置。

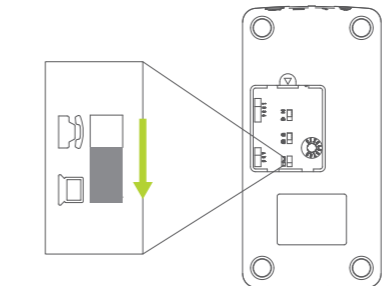

### 使用说明

#### 1. 清晰拨号音设置

由于市面上座机电话品种繁多，在首次使用 DN1200 之前需设置清晰拨号音。通过设置清晰拨号音，DN1200 可正确与您特定的座机电话匹配上。

- (1) 正确安装好 DN1200 后，戴上耳机；
- (2) 使座机电话处于通话状态；
- (3) 拨动清晰拨号音适配档位，通过 1、2、3、4 和 A、B、C 档位的配合，来回拨动尝试，直到拨号方和接听方耳机听筒中均出现最佳音质。

#### 2. 耳机麦克风音量设置

- (1) 正确安装好 DN1200 后，戴上耳机；
  - (2) 使座机电话处于通话状态；
  - (3) 调节 DN1200 上的耳机麦克风音量调节旋钮，向对方确认最佳麦克风音量后，即可直接使用。
- 注意：在此过程中，对方禁止调节其话机的音量。

#### 3. 耳机喇叭音量设置

通过耳机喇叭音量调节旋钮，使耳机喇叭中听到的声音处于最舒适状态。

#### 4. 耳机麦克风静音设置

在通话状态下，点击静音键会使您的耳机麦克风静音，对方无法听到您说话，同时静音按键指示灯点亮，再按一次静音键将恢复通话，同时静音按键指示灯熄灭。

#### 5. 话柄 / 耳机选择设置

上电后通过点击话柄 / 耳机选择按键可在话柄和耳机之间切换音频，话柄选择指示灯亮表示用话柄接听，耳机选择指示灯亮表示用耳机接听。

### 高级设置

#### 1. 语音清晰度设置

通过拨动语音清晰度开关来调整耳机喇叭的语音清晰度。拨到 [ ] 时，可提高耳机喇叭的语音清晰度；拨到 [ ] 时，恢复正常。

#### 2. 听力保护设置

通过拨动听力保护开关来设置是否进行听力保护。拨到 [ ] 时，将自动抑制超过 112dB(A) 的声音，保护耳朵；拨到 [ ] 时，恢复正常。

### 简易故障排除方法

故障现象	检查方法	解决方法
不工作	检查USB接口是否正常供电	USB接口正常供电
通话不正常	检查座机电话连接口、耳机连接口、清晰拨号音适配档位、座机/电脑选择开关是否操作正确	按照检查方法逐项排查 建议使用ADDASOUND推荐耳机
耳机有回音	是否麦克风音量设置过高	调小麦克风音量

### 保修条款

ADDASOUND 提供两年的产品保修服务，请浏览我们的官方网站 [www.addasound.cn](http://www.addasound.cn) 了解更多保修信息。

### 配件

DN1200 适配器	X1
RJ9-4P4C 音频线	X1
USB 线	X1
保修卡	X1
说明书	X1
螺丝刀	X1



ADDASOUND

ADDASOUND DENMARK A/S  
All rights reserved.  
ADDASOUND® is a registered trademark of ADDASOUND DENMARK A/S.  
All other trademarks are the property of their respective owners.

Designed and Engineered in Denmark  
Made in China

